



 SeiCom

**WINDOWS
DOORS
FACADES**



Company introduction — 3

SeiCom product groups — 5

PVC — 6

European type windows — 8

Scandinavian type windows — 10

TOP swing type windows — 12

Balcony doors — 14

Terrace and front doors — 16

Folding doors — 18

Standard sliding doors — 20

Superior sliding doors — 22

Excellent sliding doors — 24

PVC finishing options — 26

WOOD — 28

Wooden windows — 30

Aluminium clad wooden windows — 32

Balcony doors — 34

Terrace and front doors — 36

Folding doors — 38

Standard sliding doors — 40

Excellent sliding doors — 42

Wooden finishing options — 44

ALUMINIUM — 46

Window and door systems — 48

Fire-rated window and door systems — 50

Sliding and folding door systems — 54

Internal wall systems — 56

Facade systems — 58

Glazing — 62

Optional extras — 66

Bespoke windows and doors — 68



Our vision in SeiCom is to be the first choice partner for ambitious customers by offering the highest quality, delivery performance, flexibility and know-how on the market.

Our product range includes window, door and facade solutions, which are made of PVC, wood and aluminium material. This flexibility in profile materials allows us to focus on finding the right solution for our customer needs. Whether the focus is on achieving the highest thermal insulation value or the most complex glass facade – we have the knowledge and technical solutions to accomplish this.

The story behind SeiCom

SeiCom is an Estonian capital based family business founded by two brothers, Ahti Sei and Priit Sei. SeiCom started in 2002 as a manufacturer of PVC windows and doors. Over the years SeiCom has developed constantly and become the only company in Estonia to offer all window and door solutions – PVC, wood, wood-aluminium and full-aluminium.

Thanks to our team of qualified specialists, we can offer our clients a full service from drawing board to assembly. Our range of products is never ending and is constantly growing. To accomplish that, we work closely with our customers, profile manufacturers, construction companies and architects.



PVC

Comfort and simplicity

The use of PVC has been increasing rapidly in the world of windows and doors. There is a good reason for this – PVC windows and doors combine a high thermal insulation value with practicality. PVC windows and doors are long-lasting and easy to maintain. All SeiCom PVC products are available in a wide variety of decorative colors.

WOOD

Quality in traditions

Wood is a natural and sustainable material that has been used for windows and doors for centuries. Wooden windows and doors ensure a warm and cozy indoor climate. Combined with aluminum our wooden windows achieve the highest resistance against rain and sun.

ALUMINIUM

Modern glass surface

Aluminium is a strong but at the same time extremely lightweight material. Those qualities allow us to cross limits and produce even the most complex windows and facade solutions for both private and public buildings in various dimensions.

PVC

Our range of PVC products consists of three main product groups: windows, doors, and sliding doors. Three models of windows are available: common tilt and turn European type windows, traditional outwards opening Scandinavian windows, and most advanced Top Swing windows. The assortment of doors consists of inwards opening Balcony doors, outwards opening Terrace doors and a variety of Front doors. The Sliding doors come in two systems: tilt and slide and parallel slide doors. Folding doors are available in 3 or 4 door leafs. All described PVC products are available in wide range of decorative colors.

WINDOWS

European Type



Scandinavian Type



Top swing



DOORS

Balcony Doors



Terrace Doors



Front Doors



Folding Doors



SLIDING DOORS

Standard sliding Doors



Superior sliding Doors



Excellent sliding Doors





PVC EUROPEAN TYPE WINDOWS

European type windows are inwards opening windows with tilt and turn function. All our windows are fitted with micro-ventilation function. The assortment consists of four types of profile systems (SeiCom Classic, SeiCom Modern, SeiCom Premium and SeiCom SlimLine) that can be combined with three glazing options (double glass, triple glass and triple glass Energy). In addition, it is possible to choose between toughened or tempered glass, laminated glass and decorative glass. Thermal insulation value of the window depends on the combination of profile system and glass. SeiCom Premium profile is certificated for passive house standards, which combined with triple glass Energy will meet the highest expectations of energy efficiency.



Glazing	Double glazed	Triple glazed	Triple glazed Energy
Argon gas-filled	Yes	Yes (2x)	Yes (2x)
Selective glass	External glass	Middle glass	Internal and external glass
Glazing spacer	Aluminium	Double Aluminium	Chromatec Ultra



SeiCom Classic

Construction depth 74 mm	U-value 1.3 W(m ² K)	U-value 0.86 W(m ² K)	U-value 0.78 W(m ² K)
Double gasket Siegenia hardware ☞ max 47 dB			

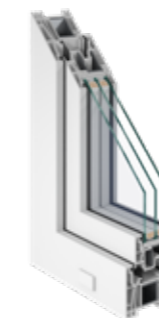

SeiCom Modern

Construction depth 74 mm	U-value 1.2 W(m ² K)	U-value 0.85 W(m ² K)	U-value 0.78 W(m ² K)
Triple gasket Siegenia hardware ☞ max 47 dB			



SeiCom Premium

Construction depth 82.5 mm	—	U-value 0.81 W(m ² K)	U-value 0.73 W(m ² K)
Triple gasket Siegenia hardware ☞ max 48 dB			

The U-value calculation is based on closed window unit size 1230x1480 mm

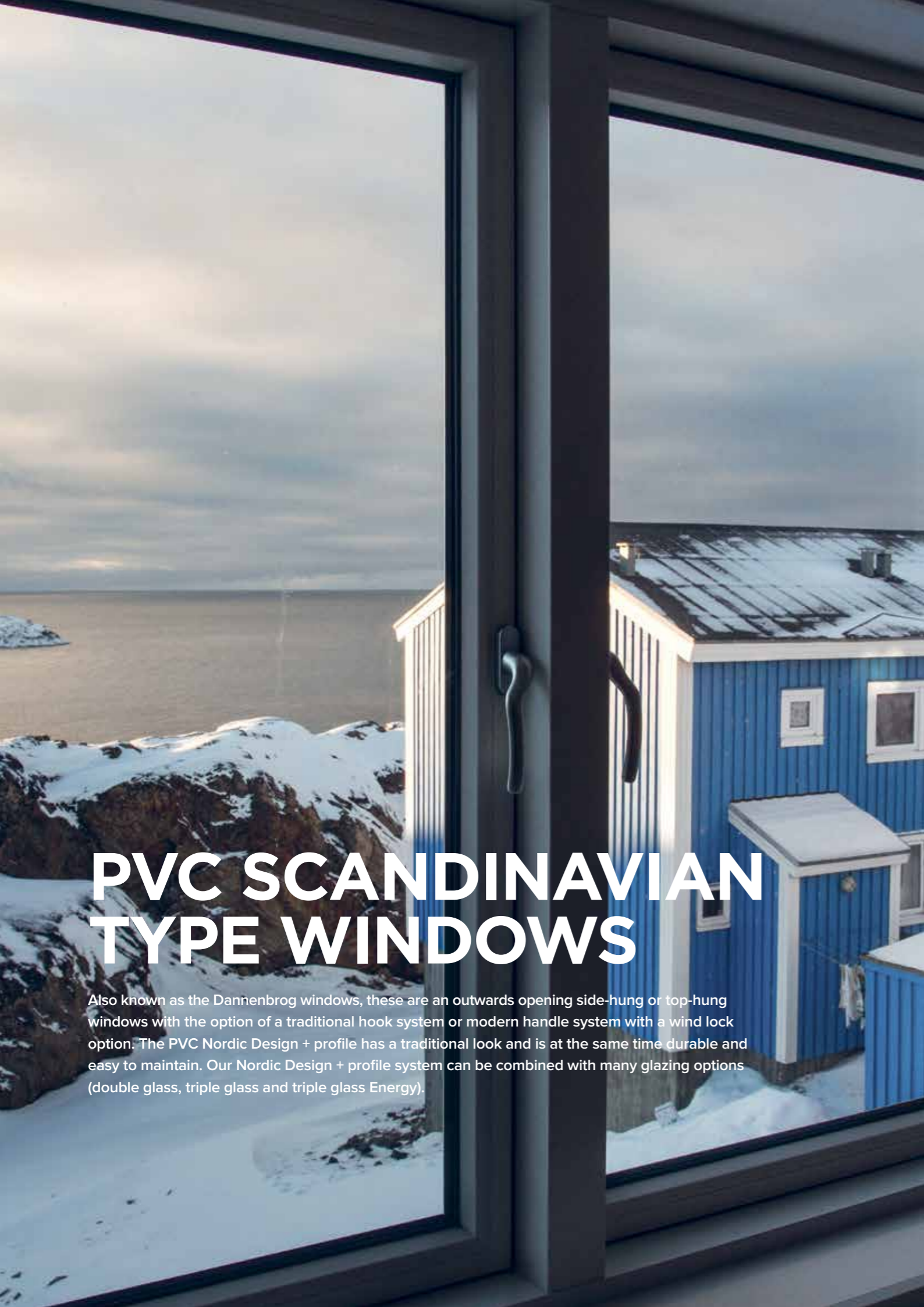

PVC SCANDINAVIAN TYPE WINDOWS

Also known as the Dannenbrog windows, these are an outwards opening side-hung or top-hung windows with the option of a traditional hook system or modern handle system with a wind lock option. The PVC Nordic Design + profile has a traditional look and is at the same time durable and easy to maintain. Our Nordic Design + profile system can be combined with many glazing options (double glass, triple glass and triple glass Energy).



Glazing	Double glazed	Triple glazed	Triple glazed Energy
Argon gas-filled	Yes	Yes (2x)	Yes (2x)
Selective glass	External glass	Middle glass	Internal and external glass
Glazing spacer	Aluminium	Double Aluminium	Chromatec Ultra



Nordic Design +

Construction depth	U-value	U-value	U-value
120 mm	1.5	1.1	0.98
	W(m ² K)	W(m ² K)	W(m ² K)

Double gasket
IPA / Mila / Siegenia
hardware
☞ max 40 dB

The U-value calculation is based on closed window unit size 1230x1480 mm



— Outwards opening
— Wind lock optional



PVC TOP SWING TYPE WINDOWS

Our Top Swing windows are fitted with ASSA/ABLOY hinge system allowing the window to be turned 180 degrees. This function is especially good for cleaning purpose. The combination of top swing functionality and PVC makes our windows most practical and easy to maintain. The Nordic Design + profile system can be combined with majority of glazing options (double glass, triple glass and triple glass Energy).



Glazing
Argon gas-filled
Selective glass
Glazing spacer

Double glazed
Yes
External glass
Aluminum

Triple glazed
Yes (2x)
Middle glass
Double Aluminium

Triple glazed Energy
Yes (2x)
Internal and external glass
Chromatec Ultra



Nordic Design +

Construction depth
120 mm

U-value
1.4
W(m²K)

U-value
1
W(m²K)

U-value
0.93
W(m²K)

Double gasket
ASSA / ABLOY / Siegenia
hardware
☞ max 40 dB

The U-value calculation is based on closed window unit size 980x980 mm





PVC BALCONY DOORS

Our Balcony doors are based on SeiCom Classic and SeiCom Premium profiles, which can be combined with many glazing options. The Balcony doors are inwards opening doors including tilt and turn mechanism. The handle of the door is only on the inside. It is possible to choose between low aluminium or regular PVC threshold.



U-value from
0.81
W(m²K)

SeiCom Classic

Construction depth
74 mm
Double gasket
Siegenia hardware
↳ max 47 dB



U-value from
0.75
W(m²K)

SeiCom Premium

Construction depth
82.5 mm
Triple gasket
Siegenia hardware
↳ max 48 dB



BALCONY DOORS

Threshold	Threshold height	Opening	Wind catch	Internal lockable handle
PVC profile / Aluminium	66/20 mm (Classic)	In	Optional extra	Optional extra
PVC profile / Aluminium	70/20 mm (Premium)	In	Optional extra	Optional extra



PVC TERRACE AND FRONT DOORS

Our Terrace and Front doors are based on SeiCom Classic, SeiCom Premium and Nordic Design+ profiles, which can be combined with many glazing options. Terrace door is outwards opening door with optional internal lockable handle. The wind lock for the terrace door is already included. Front door is outwards opening door with burglary safe profile system. Our Front doors and Terrace doors come with a low aluminium threshold as standard.



U-value from
0.84
W(m²K)

SeiCom Classic

Construction depth
74 mm
Double gasket
Siegenia hardware
↻ max 47 dB



U-value from
0.77
W(m²K)

SeiCom Premium

Construction depth
82.5 mm
Triple gasket
Siegenia hardware
↻ max 48 dB



U-value from
0.92
W(m²K)

Nordic Design +

Construction depth
120 mm
Double gasket
Siegenia hardware
↻ max 40 dB



TERRACE DOORS

Threshold	Threshold height	Opening	Wind lock	Internal lockable handle
Aluminum	20 mm (Classic, Premium)	Out	Included	Optional extra
Aluminum	25 mm (Nordic Design +)	Out	Included	Optional extra



FRONT DOORS

Threshold	Threshold height	Opening	External handle and lock	Cylinder lock
Aluminum	20 mm (Classic, Premium)	In or Out	Included	Euro cylinder lock
Aluminum	25 mm (Nordic Design +)	Out	Included	Euro cylinder lock



PVC FOLDING DOORS

Our PVC Folding doors are based on SeiCom Classic profile. We have pushed the boundaries and developed an affordable folding door, which does not compromise on quality. Folding door is a good alternative for sliding door, if most of the time it is used as a regular door.



SeiCom Classic

Construction depth
74 mm
Double gasket
Siegenia hardware
☞ max 47 dB

U-value from
0.84
W(m²K)

Threshold	Threshold height	Opening	Wind catch	External handle and lock
PVC profile	102 mm	Folding inwards	Optional extra	Optional extra

The U-value calculation is based on closed window unit size 2400x2100 mm



OPENING SCHEMES

1.

max 2 736 mm

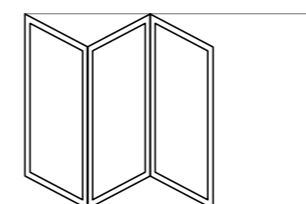

2 448 mm

3.

max 3 648 mm

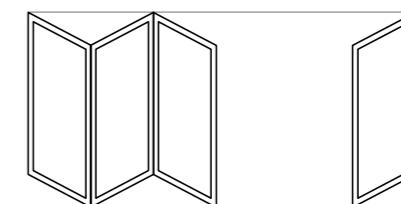

2 448 mm



PVC STANDARD SLIDING DOOR

This well designed and practical sliding door system, also known as tilt and slide (PSK) door, is multifunctional and at the same time easy to use. In addition to slide opening function, it also includes a tilt function for ventilation purpose. Our Standard Sliding doors are available in two profile systems (SeiCom Classic and SeiCom Premium).



SeiCom Classic

Construction depth
74 mm
Double gasket
Siegenia hardware
47 dB

U-value from
0.83
W(m²K)

Threshold	Threshold height	Opening
PVC profile	66 mm	Tilt and slide inwards



SeiCom Premium

Construction depth
82.5 mm
Triple gasket
Siegenia hardware
max 48 dB

U-value
0.73
W(m²K)

Threshold	Threshold height	Opening
PVC profile	70 mm	Tilt and slide inwards

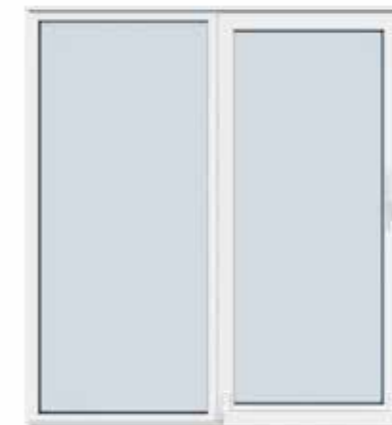

OPENING SCHEME

A

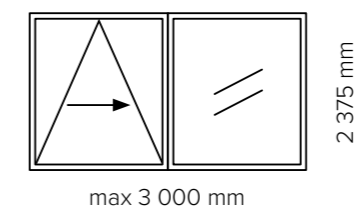

Maximum measures are based on white colored standard sliding doors.



PVC SUPERIOR SLIDING DOORS

These modern design parallel sliding doors are easy to use due to their roller slides and comfortable locking system. Thin profiles offer more glass area to fill the room with natural light. The threshold is strengthened with aluminium cover. The profile can be combined with triple or triple Energy glazing.

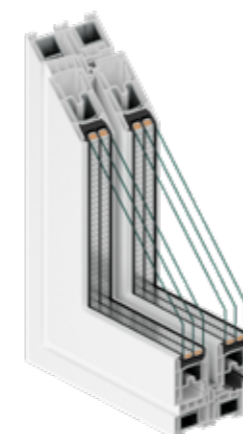

SeiCom Superior

Construction depth
150 mm
Double gasket
Roto hardware
↳ max 43 dB

U-value from
0.87
W(m²K)

Threshold	Threshold height	Opening	External handle and lock
PVC profile + Aluminium cover	74 mm	Parallel slide	Optional extra



OPENING SCHEME

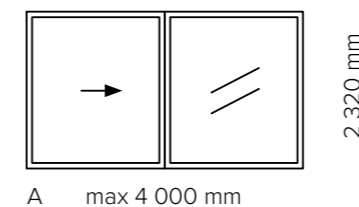

Maximum measures are based on white colored standard sliding doors.



PVC EXCELLENT SLIDING DOORS

It does not matter whether the door is open or closed, either way the room is flooded with light. Sliding elements are a classic design features in modern living, with large expanses of glass conveying a feeling of well-being and elegance. Our Excellent Sliding doors, also known as parallel Lift and Slide doors (HST), are fitted with low aluminium threshold and there is a choice from majority of glazing options.



SeiCom Excellent

Construction depth
190 mm
Double gasket
Siegenia hardware
⇄ max 42 dB

U-value from
0.83
W(m²K)

Threshold	Threshold height	Opening	Wind catch	External handle and lock
Aluminium	0/50 mm	Parallel slide	Included	Optional extra

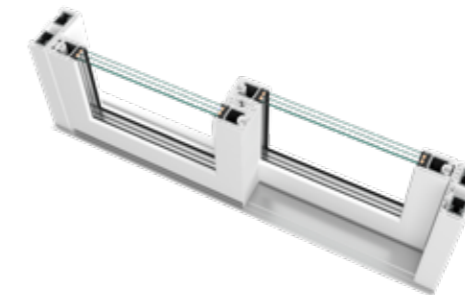

OPENING SCHEMES

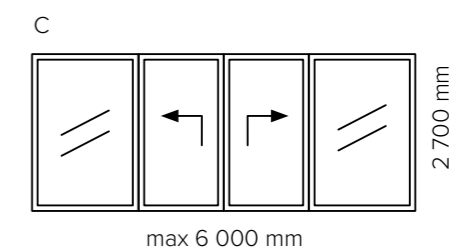
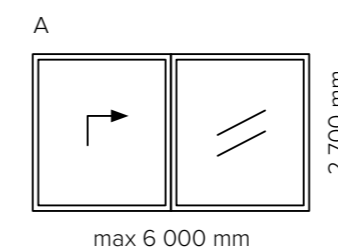

Maximum measures are based on white colored standard sliding doors.

PVC WINDOW AND DOOR FINISHING OPTIONS

PVC decorative foils



PVC decorative foils offer a natural wood grain appearance and colored look without sacrificing the benefits of modern window technology. Windows with decor foils offer all the positive properties of modern PVC windows and doors combined with the decorative effect of wood. Decorative foils can be used to finish the inside and outside of the windows and doors. We offer a choice of more than 50 different colors of decorative foil.

Real Wood foil



Real Wood foil

Standard Wood Decor foil

The Real Wood foil is a further developed foil to give the windows a more wood-like appearance. The Real Wood foils have an attractive embossing and do not shimmer as much as standard wood decor foils. Those features give the PVC window the natural appearance of real wood. The Real Wood foils are available in six standard colors.

Acrylcolor

Acrylcolor – the acrylic color layer is twice as hard as the regular white surface of PVC windows. It is highly scratch and weather effect resistant. The semi-matt, smooth and non-porous acrylcolor surface is insensitive to accumulations of dust and dirt. The acrylcolor layer does not separate and crack. Acrylcolor PVC windows and doors require virtually no maintenance nor laborious repainting and are extremely easy to care for. Acrylcolor is available only for the exterior of the windows and doors. Acrylcolor finish is available in 9 standard colours.

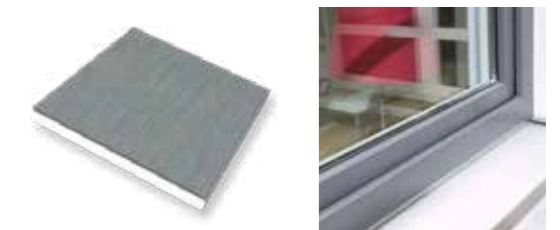

WOOD

SeiCom range of wooden products consists of four main product groups: windows, doors, sliding doors and folding doors which all are available in SeiCom Classic (78 mm) and SeiCom Premium (92 mm) frame qualities. Our wooden windows and doors are made from engineered timber: pine (finger jointed and laminated), oak (laminated) and meranti (laminated). Engineered timber improves the thermal insulation value as well as improves the strength of the frame, making it less receptive to any kind of twisting or warping. Both frames are available with an aluminum cladding option making the windows and doors especially weather resistant. All described windows and doors are available in a wide range of stains or paints. The inside and outside of the frame can be finished in different treatments.

WINDOWS

European type



DOORS

Balcony Doors



Terrace Doors



Front Doors



Folding Doors



SLIDING DOORS

Standard sliding Doors



Excellent sliding Doors





WOODEN WINDOWS

SeiCom inwards opening tilt and turn windows come with micro-ventilation function as a standard. The range consists of SeiCom Classic IV78 and SeiCom Premium IV92 frame qualities. Both options are available with fire resistance class EI30 for single opening and non-opening units. All wooden windows are fitted with painted aluminium water drip-bar on the outside. SeiCom Classic IV78 frame can be combined with four glazing options and SeiCom Premium IV92 frame with three glazing options.



Glazing	Double glazed	Triple glazed	Triple glazed Energy	Triple glazed Energy +
Argon gas-filled	Yes	Yes (2x)	Yes (2x)	Yes (2x)
Selective glass	External glass	Middle glass	Internal and external glass	Internal and external glass
Glazing spacer	Aluminium	Double Aluminium	Chromatec Ultra	Chromatec Ultra



SeiCom Classic (IV78)

Construction depth	U-value	U-value	U-value	U-value
78 mm	1.4	0.97	0.85	0.83
	W(m ² K)	W(m ² K)	W(m ² K)	W(m ² K)
Double gasket				
Pine / Oak / Meranti				
Siegenia hardware				
☞ max 48 dB				



SeiCom Premium (IV92)

Construction depth	U-value	U-value	U-value	U-value
92 mm	—	0.93	0.8	0.77
		W(m ² K)	W(m ² K)	W(m ² K)
Double gasket				
Pine / Oak / Meranti				
Siegenia hardware				
☞ 50 max dB				



SeiCom Classic FIRE (IV78) ^{Fire rated} EI30

Construction depth	U-value	U-value	U-value	U-value
78 mm	1.4	1.4	—	1.3
	W(m ² K)	W(m ² K)		W(m ² K)
Double gasket				
Pine / Oak				
Siegenia hardware				
☞ max 48 dB				



SeiCom Premium FIRE (IV92) ^{Fire rated} EI30

Construction depth	U-value	U-value	U-value	U-value
92 mm	—	0.97	—	0.92
		W(m ² K)		W(m ² K)
Double gasket				
Pine / Oak				
Siegenia hardware				
☞ max 50 dB				

The U-value calculation is based on closed window unit size 1230x1480 mm



ALUMINIUM CLAD WOODEN WINDOWS

SeiCom wooden European type window range is also available with aluminium cladding on the outside. The aluminium cladding makes the windows especially resistant to all kinds of weather conditions. The aluminium cladding is easy to clean and more resistant to mechanical damages.



Glazing	Double glazed	Triple glazed	Triple glazed Energy	Triple glazed Energy +
Argon gas-filled	Yes	Yes (2x)	Yes (2x)	Yes (2x)
Selective glass	External glass	Middle glass	Internal and external glass	Internal and external glass
Glazing spacer	Aluminium	Double Aluminium	Chromatec Ultra	Chromatec Ultra

SeiCom Classic ALU (IV78)



Construction depth	U-value	U-value	U-value	U-value
90 mm	1.4	0.97	0.85	0.83
	W(m ² K)	W(m ² K)	W(m ² K)	W(m ² K)
Double gasket	Pine / Oak / Meranti			
Siegenia hardware	↳ max 48 dB			

SeiCom Premium ALU (IV92)



Construction depth	U-value	U-value	U-value	U-value
104 mm	—	0.93	0.78	0.77
		W(m ² K)	W(m ² K)	W(m ² K)
Double gasket	Pine / Oak / Meranti			
Siegenia hardware	↳ max 50 dB			

SeiCom Classic ALU FIRE (IV78) ^{Fire rated} EI30



Construction depth	U-value	U-value	U-value	U-value
90 mm	1.4	1.4	—	1.3
	W(m ² K)	W(m ² K)		W(m ² K)
Double gasket	Pine / Oak			
Siegenia hardware	↳ max 48 dB			

SeiCom Premium ALU FIRE (IV92) ^{Fire rated} EI30







Construction depth	U-value	U-value	U-value	U-value
104 mm	—	0.97	—	0.92
		W(m ² K)		W(m ² K)
Double gasket	Pine / Oak			
Siegenia hardware	↳ max 50 dB			

The U-value calculation is based on closed window unit size 1230x1480 mm



WOODEN AND ALUMINIUM CLAD BALCONY DOORS

Our wooden Balcony doors are based on four different types of profile systems. The Balcony doors are inwards opening doors including tilt and turn mechanism. The handle of the door is only on the inside. It is possible to choose between low aluminium or regular wood profile threshold.

<p>ONE U-value from 0.86 W(m²K)</p> 	<p>ONE U-value from 0.79 W(m²K)</p> 	<p>ONE U-value from 0.86 W(m²K)</p> 	<p>ONE U-value from 0.79 W(m²K)</p> 
<p>SeiCom Classic (IV78)</p> <p>Construction depth 78 mm Double gasket Pine / Oak / Meranti Siegenia hardware ↔ max 48 dB</p>	<p>SeiCom Premium (IV92)</p> <p>Construction depth 92 mm Double gasket Pine / Oak / Meranti Siegenia hardware ↔ max 50 dB</p>	<p>SeiCom Classic ALU (IV78)</p> <p>Construction depth 90 mm Double gasket Pine / Oak / Meranti Siegenia hardware ↔ max 48 dB</p>	<p>SeiCom Premium ALU (IV92)</p> <p>Construction depth 104 mm Double gasket Pine / Oak / Meranti Siegenia hardware ↔ max 50 dB</p>



BALCONY DOORS

Threshold	Threshold height	Opening	Wind catch	External handle and lock	Internal lockable handle
Standard/ Aluminium	92,5/32 mm (Classic, Premium)	In, tilt and turn	Optional extra	Optional extra, Euro cylinder	Optional extra
Standard/ Aluminium	109/32 mm (Classic ALU, Premium ALU)	In, tilt and turn	Optional extra	Optional extra, Euro cylinder	Optional extra



WOODEN AND ALUMINIUM CLAD TERRACE AND FRONT DOORS

Our wooden Terrace and Front doors are based on four different types of profile systems. Terrace door is inwards or outwards opening door with optional handle on both sides. The wind lock for the terrace door is already included. Front door is outwards opening door with burglary safe profile system. Our Front doors and Terrace doors come with a low aluminium threshold as standard.

<p>ONE U-value from 0.96 W(m²K)</p> 	<p>ONE U-value from 0.96 W(m²K)</p> 	<p>ONE U-value from 0.96 W(m²K)</p> 	<p>ONE U-value from 0.96 W(m²K)</p> 
<p>SeiCom Classic (IV78)</p> <p>Construction depth 78 mm Single gasket Pine / Oak / Meranti ⇄ max 46 dB</p>	<p>SeiCom Premium (IV92)</p> <p>Construction depth 92 mm Single gasket Pine / Oak / Meranti ⇄ max 46 dB</p>	<p>SeiCom Classic ALU (IV78)</p> <p>Construction depth 90 mm Single gasket Pine / Oak / Meranti ⇄ max 46 dB</p>	<p>SeiCom Premium ALU (IV92)</p> <p>Construction depth 104 mm Single gasket Pine / Oak / Meranti ⇄ max 46 dB</p>



TERRACE DOORS

Threshold	Threshold height	Opening	Wind lock	External handle and lock
Aluminium	32 mm	In or Out	Included	Optional extra

Hardware
Classic, Premium – ASSA / ABLOY / IPA / FIX
Classic ALU, Premium ALU – ASSA / IPA / FIX



FRONT DOORS

Threshold	Threshold height	Opening	External handle and lock
Aluminium	32 mm	Out	Included

Hardware
Classic, Premium – ASSA / ABLOY / GU
Classic ALU, Premium ALU – ASSA / IPA / GU

Threshold	Threshold height	Opening	External handle and lock
Standard	104 mm	Folding, inwards	Optional extra



ONE U-value from
0.83
W(m²K)

**SeiCom
Classic (IV78) Folding**

Construction depth
78 mm
Double gasket
Pine / Oak / Meranti
Hautau / Siegenia hardware
⇄ max 48 dB



ONE U-value from
0.77
W(m²K)

**SeiCom
Premium (IV92) Folding**

Construction depth
92 mm
Double gasket
Pine / Oak / Meranti
Hautau / Siegenia hardware
⇄ max 50 dB

OPENING SCHEMES

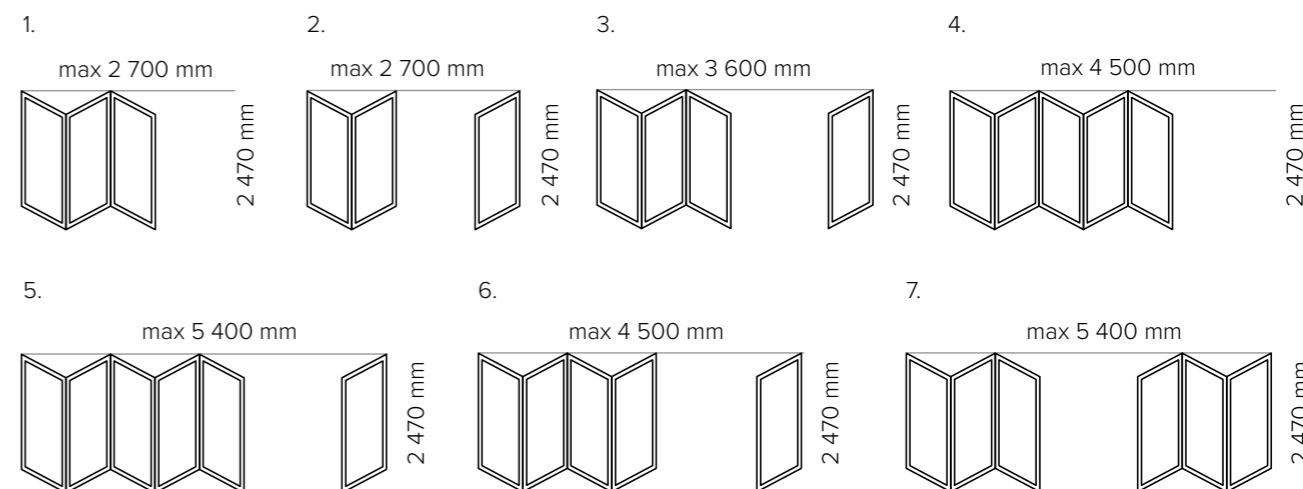

WOODEN FOLDING DOORS

Seicom Folding door range offers a versatile choice of different opening schemes, which allow unlimited possibilities for use. Our wooden Folding doors are available in two profile systems (SeiCom Classic IV78 and SeiCom Premium IV92) which can be combined with many glazing options.

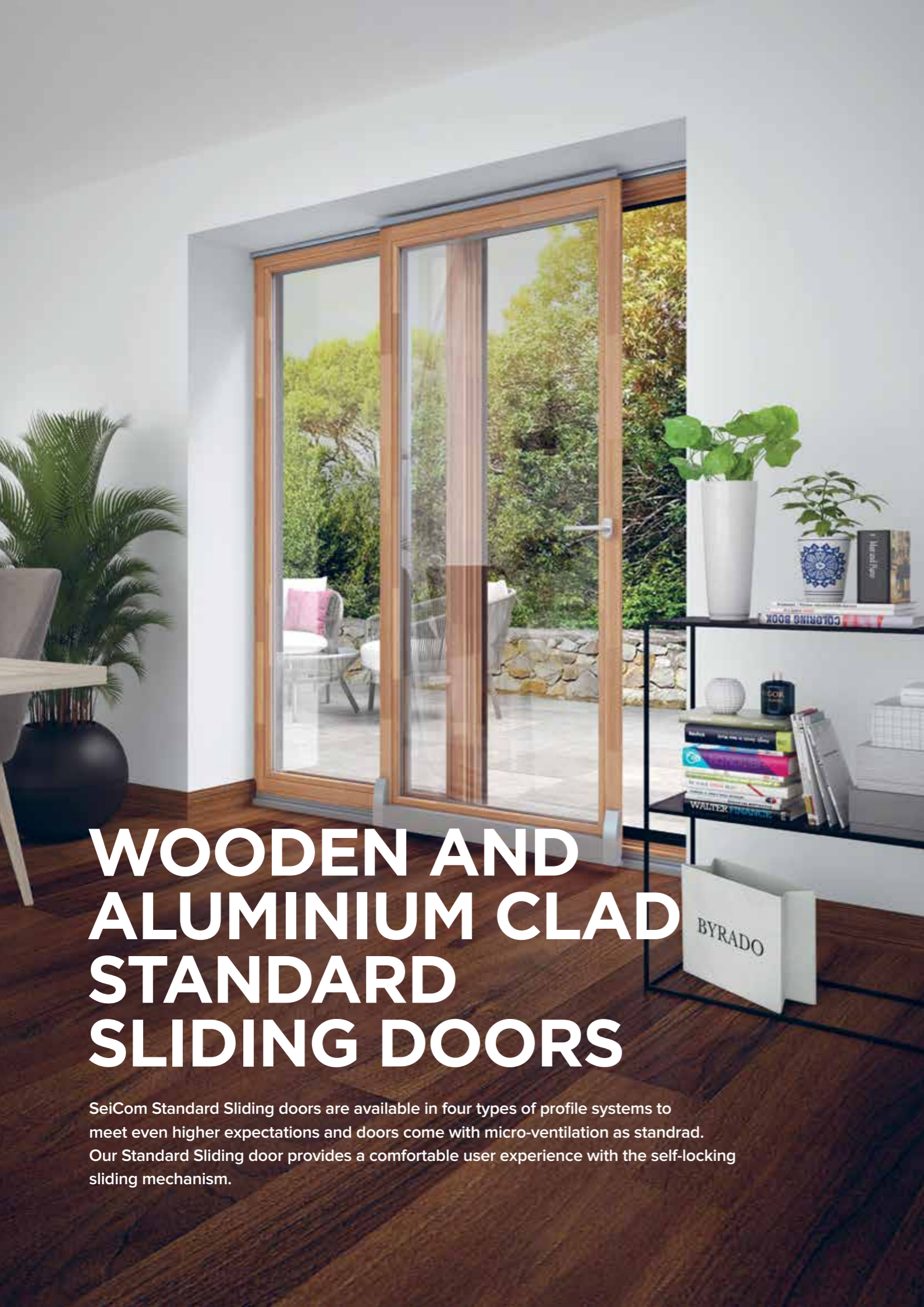

WOODEN AND ALUMINIUM CLAD STANDARD SLIDING DOORS

SeiCom Standard Sliding doors are available in four types of profile systems to meet even higher expectations and doors come with micro-ventilation as standard. Our Standard Sliding door provides a comfortable user experience with the self-locking sliding mechanism.

ONE U-value from
0.75
W(m²K)



SeiCom Classic (IV78)

Construction depth
78 mm
Double gasket
Pine / Oak / Meranti
Hautau / Siegenia hardware
☞ max 48 dB

ONE U-value from
0.71
W(m²K)



SeiCom Premium (IV92)

Construction depth
92 mm
Double gasket
Pine / Oak / Meranti
Hautau / Siegenia hardware
☞ max 50 dB

ONE U-value from
0.75
W(m²K)



SeiCom Classic ALU (IV78)

Construction depth
90 mm
Double gasket
Pine / Oak / Meranti
Hautau / Siegenia hardware
☞ max 48 dB

ONE U-value from
0.71
W(m²K)



SeiCom Premium ALU (IV92)

Construction depth
104 mm
Double gasket
Pine / Oak / Meranti
Hautau / Siegenia hardware
☞ 50 dB

Threshold	Threshold height	Opening	External handle and lock
Standard	92 mm (Classic, Premium) 109 mm (Classic ALU, Premium ALU)	Slide inwards	Optional extra



OPENING SCHEMES

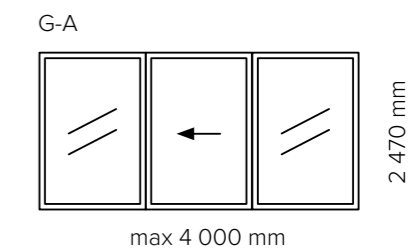
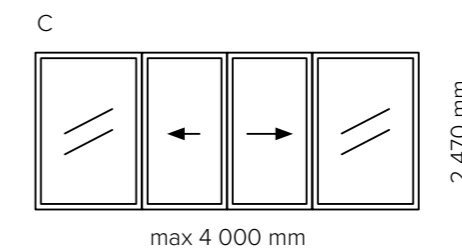
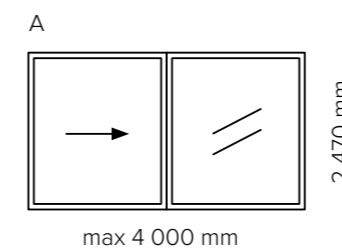

For longer sliding doors it is possible to add extra module

WOODEN AND ALUMINIUM CLAD EXCELLENT SLIDING DOORS

SeiCom Excellent Sliding doors (also known as parallel HST doors) offer lots of light and design freedom. They are practical to use and at the same time present an excellent thermal insulation value. All our Excellent Sliding doors are available with flush aluminium threshold and soft close.



SeiCom Excellent (IV78)

Construction depth **184 mm** ONE U-value from **0.8**
 Double gasket W(m²K)
 Pine / Oak / Meranti
 Siegenia hardware
 ⇩) max 48 dB

Threshold	Threshold height	Opening	External handle and lock
PVC-Aluminum	0/50 mm	Parallel slide	Optional extra

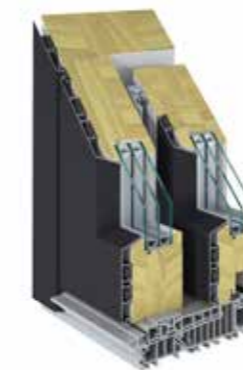

SeiCom Excellent ALU (IV78)

Construction depth **216 mm** ONE U-value from **0.8**
 Double gasket W(m²K)
 Pine / Oak / Meranti
 Siegenia hardware
 ⇩) max 48 dB

Threshold	Threshold height	Opening	External handle and lock
PVC-Aluminum	0/50 mm	Parallel slide	Optional extra



OPENING SCHEME

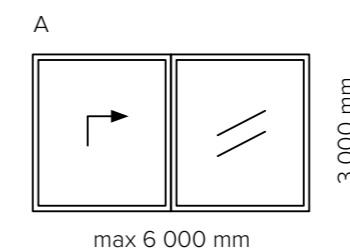

For longer sliding doors it is possible to add extra module

WOODEN FINISHING OPTIONS

SeiCom is very proud to offer hand finished wooden windows and doors. The windows and doors are dip treated against blue stain and mould. Sanded two times – before and after the base layer of paint is applied. The final finish coating is applied by hand and all joints are filled with special filler to prevent any kind of moisture penetration. For the final finishing we offer the full classic RAL color chart and dozens of wood stains to choose from. Of course the interior and exterior can have a different color or stain. This versatile choice of finishes offers flexibility for even the most demanding interior design.

RAL color chart

Wood and aluminum clad windows and doors can be ordered in all colors from RAL color chart.



Selection of stains

We offer a wide range of wood stains for windows and doors.



ALUMINIUM

SeiCom aluminium systems allow you to fabricate many different types of windows, doors, internal partition walls and facade solutions. These can depend on the scope and specific requirements for functionality, aesthetics, thermal insulation, burglary resistance, smoke control or fire resistance. These include both structures with no thermal insulation and solutions based on thermally insulated profiles. All SeiCom aluminium products are based on Aluprof SA systems.

WINDOW AND DOOR SYSTEMS

European type



Scandinavian type



Top swing



Balcony



Terrace



Front



SLIDING AND FOLDING SYSTEMS

Lift & Slide (HST)



Folding



FACADES SYSTEMS

Facade systems



Internal wall systems





ALUMINIUM WINDOW AND DOOR SYSTEMS



MB-86

Construction depth
77 mm

U-value from
0.72
W(m²K)

The new MB-86 window and door series have been designed to offer outstanding insulation properties. It meets the increasing requirements from the legislative and general market demands for the enhanced energy saving construction of new windows and doors.

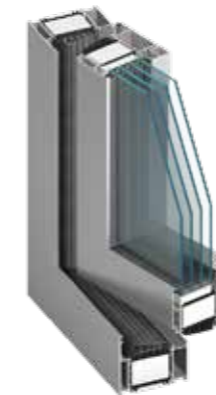

MB-104

Construction depth
95 mm

U-value from
0.53
W(m²K)

The MB-104 Passive is a thermal break-equipped window & door system that provides the highest thermal insulation performance and meets all the requirements for passive building components.

PASSIVE HOUSE



Panel doors

Construction depth
77/95 mm

U-value from
0.63
W(m²K)

Our range includes panel doors based on the MB-86 and MB-104 system. This is a visually attractive and at the same time technologically advanced product. Due to its design solutions and the rich diversity of colors for door fill, it can be, not only the functional and durable entrance into your home, but also its mark and decoration.

PASSIVE HOUSE



MB-45

Construction depth
45 mm

MB-45 is a modern aluminium system intended for designing elements of architectural exterior and interior enclosures that do not require thermal insulation, e.g. various types of partition walls, windows, manual and automatic sliding doors, swing doors, vestibules, display windows, ticket box offices, showcases and spatial structures.

FIRE-RATED ALUMINIUM WINDOW AND DOOR SYSTEMS

A wide range of systems facilitate a variety of structural elements that are responsible for “fire protection zones” in buildings and provide the right conditions for evacuation of its occupants. These solutions include window, wall and door system options.

The fire resistance performance of these solutions, depending on the project requirements, are available in a variety of classes, from EI 30 to EI 120. An important feature of fire rated solutions is their ability to interface with each other, one system to the next, whilst maintaining the necessary fire resistance.



MB-86EI

Construction depth
86 mm

Fire rated
EI 30

U-value from
0.86
W(m²K)

MB-86EI is used for fabrication of EI30 fire-rated openable windows and doors to EN 13501- 2+A1. MB-86EI is based on MB-86 system and has excellent thermal, sound reduction, water retardant and air leakage performances. The MB-86EI combines the advantages of a classic window system with the properties of a fire partition walling – the construction meets all the requirements of the applicable regulations and standards, especially regarding energy saving and environmental protection, while ensuring proper fire safety.



MB-60E EI

Construction depth
60 mm

Fire rated
EI 30

MB-60E EI enables the fabrication of fire-resisting internal or exterior, single or double leaf doors. It also enables the fabrication of “technical windows” and fire retardant partitions. MB-60E EI-based constructions are classified EI15 or EI30 to PN-EN 13501-2+A1:2010.

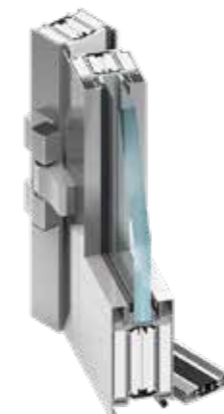

MB-78EI

Construction depth
78 mm

Fire rated
EI 30–EI 90

The MB-78EI fire partition system is intended for producing internal or external fire partition walls with single- or double-leaf doors with a fire retardant class of EI 15, EI 30, EI 45, EI 60 or EI 90, according to the PN-EN 13501-2+A1:2010 norm.

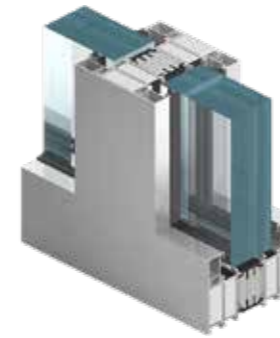

MB-118EI

Construction depth
118 mm

Low Threshold,
wheelchair accessible

Fire rated
EI 30–EI 120

The MB-118EI system is based on MB-78EI and is used to fabricate EI120-fire rated structures. The system has been developed on the basis of a five chamber insulated aluminium profile, with a front to back depth of 118 mm. The inner chamber profiles, as well as insulating space between them, are filled with fire insulation elements. On the outer surfaces there are expanding tapes which are additionally mounted and the whole structure is completed by steel accessories components, joining both sides of the profiles. Thanks to its symmetrical composition, the structures that are made of it remain fire resistant in EI 120 class, both exposed to fire from the outside and the inside.



SMOKE EXHAUST WINDOWS AND FLAPS

Certificates

Certificates confirming compliance with the requirements of the EN 12101-2: 2003 standard.

The smoke exhaust windows and flaps play a particular role in ensuring safety and comfort for the people staying in the building. When properly selected, they are the elements of gravity ventilation, and when necessary they can help to quickly get rid of smoke and toxic vapours which may be dangerous for health and life. The offer for these products is characterised by the diversity of solutions so they can be used in an individual development, as well as elements integrated with aluminium facades or roof glazed panels.

ALUMINIUM SLIDING AND FOLDING DOOR SYSTEMS



MB-77HS sliding door system

Construction depth
174 mm
Optional low threshold
(wheelchair accessible)

U-value from
0.84
W(m²K)

The MB-77HS "Lift & Slide" door product is an ideal solution for connecting interior space rooms or conservatories with the outside balcony, terrace or garden area.



MB-86 FOLD folding door system

Construction depth
86 mm
Optional low threshold
(wheelchair accessible)

U-value from
1.5
W(m²K)

Exterior folding doors offer greater flexibility to their users. They enable us to use weather conditions to our advantage and virtually eliminate the barrier between the interior space and its surroundings. With its excellent technical parameters, MB-86 FOLD LINE is a very convenient solution that enables the fabrication of large-dimension structures. Folding doors can be opened both outwards and inwards and its leaves can be freely configured. It is a modern product, designed to meet the high demands of users, architects and owners.



MB SKYLINE sliding door system

Construction depth
71/190/292 mm
Optional low threshold
(wheelchair accessible)

U-value from
0.85
W(m²K)

The MB-SKYLINE sliding door system with invisible frame uses narrow profiles. This gives the construction a modern and minimalist look. Constructions fabricated with MB-SKYLINE have one-of-a-kind design and raise the profile of any project. They provide a comfortable, threshold-free connection of indoor and outdoor living spaces, making natural environment part of users' daily experience. While the doors can be very large, their slim construction gives the impression of lightness and delicacy. The product is uniformly glazed, has slim modulations and perfectly fits into high-end construction market.



ALUMINIUM INTERNAL WALL SYSTEMS



MB-45 OFFICE

Construction depth
45 mm

The MB-45 OFFICE fixed and door equipped partitioning system has been designed to fabricate internal partition walls whose distinguishing feature is that a tempered glass pane can be its structural component. Due to its versatility and wide application possibilities, the MB-45 OFFICE system is dedicated to the fabrication of lightweight, yet solid walls in meeting rooms and office spaces with “clearly marked” door. The elements of this system allow to fabricate fixed partition walls and all-glass door leaves for hinged and swinging-type doors. MB-45 OFFICE is available in a wide range of colors- RAL and wood-like ADEC.



MB-80 OFFICE

Construction depth
80/92 mm
↔ max 45 dB

The internal partition double-glass walling system is designed to fabricate internal partitions in offices and other public facilities. The system enables the use of different types of infills, transparent or obscure, with internal louvers and electrical components and office equipment. These walls are especially suitable in buildings where a high sound insulation is required. The basic feature of this construction is its versatility in arranging office space, combined with the simplicity of execution of all the works on site. The MB-80 OFFICE system is also available as a “silicone-jointed” version, both for straight and angled connections.

ALUMINIUM FACADE SYSTEMS

Our facade systems are used to fabricate glass facades of buildings such as banks, hotels, administration offices, office buildings, car showrooms, gyms, etc. They are also used for multiple spatial structures and roof glazing that light the interior and create a suitable atmosphere and comfort to its users. They are an excellent tool for shaping contemporary architecture and implementing designers' bold visions. The most popular among these products are the mullion-transom systems.

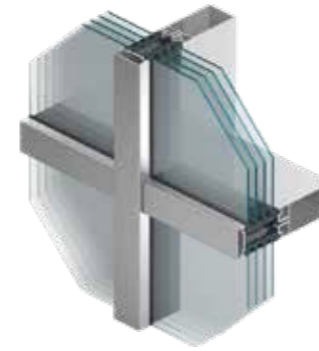

MB-TT50

PASSIVE HOUSE

U-value
from (frame)
0.59
W(m²K)

The new, modern MB-TT50 curtain wall system goes a step ahead in functionality and effectiveness compared to classic crossbar facades. It offers exceptional insulation and weather performance achieved by special 3 zone cascade drainage and ventilation of the glazing rebates. Its innovative construction enables to considerably reduce the time required to manufacture and construct the complete curtain wall. It is designed to serve as the base system for security anti burglary and fire rated varieties.



MB-SR50N HI+

PASSIVE HOUSE

U-value
from (frame)
0.7
W(m²K)

This system allows facades to be constructed with visible narrow dividing lines while ensuring the durability and strength of the structure. The wide offer of profiles enables architects and designers to realise even the most enterprising ideas for aluminium and glass structures. To obtain the optimum thermal and acoustic insulation and facilitate mounting in the MB-SR50N HI+ system facade, the PE insulator is used, as it provides a very good thermal insulation ((Uf) from 0,59 W/m2K) and its shape ensures proper screw driving when glazing the facade.

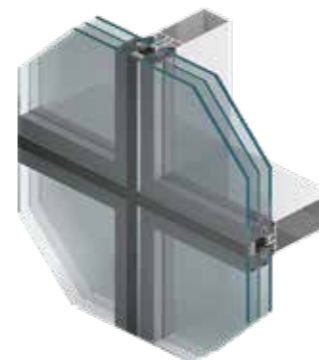

MB-SR50N Efekt

U-value
from (frame)
1.1
W(m²K)

MB-SR50N EFEKT is a facade solution that provides a uniform external appearance of a smooth glass wall divided by the structure of vertical and horizontal lines of 2 cm, thanks to the use of a special system for fixing panes to mullions and transoms. The gaps between glass fields of the facade are filled with a special silicon binder to ensure high tightness of the construction and enhance its insulation properties.



MB-SR50N EI

Fire rated
EI 30 – EI 60

U-value
from (frame)
1.8
W(m²K)

The mullion-transom system MB-SR50N EI is intended for the construction and execution of light fire resistant curtain and filling walls of the fire resistance class EI15, EI30, EI45, EI60 according to the standards PN-EN 1364-3 and PN-EN 1364-1 as well as glazed roof coverings of the fire resistance class RE30 as per the standard PN-EN 1365-2. The system has been classified as non-fire-propagating (NFP).

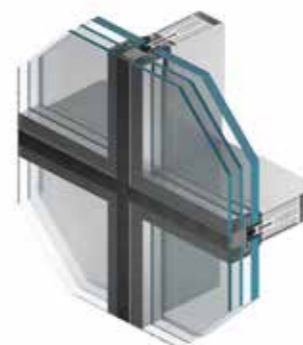

MB-SR50N EI EFEKT

Fire rated
EI 30 – EI 60

U-value
from (frame)
1.1
W(m²K)

Due to the application of a special system of fitting glass panels to mullions and transoms, a smooth surface is obtained on the outside, divided by a grid of vertical and horizontal lines 24 mm wide. The facade executed in this system ensures excellent performance characteristics and thanks to the possibility of application of two-chamber glazing - very high thermal insulation performance is achieved, which is, in view of the world-wide trend oriented towards reduction in energy consumption, one of the fundamental criteria of assessment of curtain walls.

A load bearing structure consists of vertical (mullions) and horizontal (transoms) aluminium profiles of box section, appropriately joined with each other and accessories with the function of sealing and connecting. The assortment of transoms falls into two groups of profiles (1 & 2) featuring different resistance parameters. Load-bearing profiles, which are flush on the inside of the facade feature fixed width of 50mm. The facade is mounted onto the building by means of a system of consoles, meeting the intended use and featuring appropriate load capacity.

GLAZING

Glass plays an important role in the whole window and door solution. Whether it is the cost of the total unit or the thermal insulation value of the house – choosing the right glass can make a big difference. In our assortment we offer four types of glass as standard (double glazing, triple glazing, triple glazing Energy and additionally Energy + glass as standard for wooden and aluminum clad wooden windows and doors). Other type of glazing are available on request. All our glazing options are available as toughened or security glass. For more privacy, there are different decorative finish options.

SeiCom glazing



SeiCom standard Double glass consists of two layers of 4 mm glass with argon gas filled gap in between. The internal layer of a glass is selective glass. The glazing unit spacer bar is made out of aluminium.

U-value of the glass is 1,1 W(m²K) Sun protection factor (g): 0,64



SeiCom standard Triple glass consists of three layers of 4 mm glass with argon gas filled gaps in between. The inner layers of external glasses are selective. The glazing unit spacer bar is made out of aluminium.

U-value of the glass: 0,52 W(m²K) Sun protection factor (g): 0,53



SeiCom Energy glass also consists of three layers of 4 mm glass with argon gas filled gaps in between and the inner layers of external glasses are selective. But unlike the standard triple glass, the glazing unit spacer bar is **Chromatec Ultra**, which is for better thermal insulation and vapour barrier. Selective glass with this spacer bar offers great energy-saving features, which are used to reduce heat loss. It has multiple advantages: there are no cold areas around the window, technology of the glass reduces incidence of condensation and also lets maximum daylight into the room.

U-value of the glass: 0,52 W(m²K) Sun protection factor (g): 0,53



SeiCom Energy + glass is a step forward in the world of glass. It has all the excellent properties of Energy glass, but development in glass itself allows the heating costs to be even more lower. Thanks to advanced technology, it is the best solution for the customer, who desires maximum energy efficiency and well-being.

U-value of the glass: 0,47 W(m²K) Sun protection factor (g): 0,39

Toughened or Tempered glass

Toughened or Tempered glass is a type of safety glass where the strength is increased by thermal treatment. Such treatment also causes the glass, when broken, to crumble into small granular chunks with blunt edges. The granular chunks are less likely to cause injury.



Laminated glass

Laminated glass, also known as security glass is comprised of two or more sheets of glass bonded together with one or more inter-layers of polyvinyl butyral (PVB) film. If it should break, the glass will tend to remain in its frame.



Sun protection glass

The sun protection glass has high-tech coatings, which provide maximum sun protection, but at the same time it has high natural daylight transmission. The higher the sun protection factor, the lower the cost of the room conditioning, as the room does not overheat. With this advantage we can offer our customers a feeling of well-being throughout the day.



Tinted glass

Also known as Parsol, is often chosen for design purposes, but it also has a sun protection function. Most popular three colors are green, gray and bronze. The green glass is recommended, if the glass is also meant for sun protection, because it achieves the optimal balance between the transmission of visible light and the blocking of thermal energy. Gray and bronze Parsol are mostly used as a design element.



Mirror effect glass

The mirror glass has high reflection level. It gives more private feeling. This kind of glass is, for example, chosen for offices. As there are many different color options to choose from, it can also be used as a decorative element.



Decorative obscure glazing

One side of the decorative glass is embossed to make it obscure. Such glasses are mainly used for privacy or just as a design element. In our assortment we offer four types of obscure glass – Raaka, Crepi, Kura and Satin.



Raaka



Crepi



Kura



Satin

Decorative glazing bars

We offer a wide range of different design decorative window glazing bars for our windows and doors that can be assembled on the glass and in between the glazing.



Insect nets for windows

SeiCom offers insect nets for inwards opening European style windows. Insect net frames are made of an aluminium profile and the net is almost invisible so it doesn't affect the look of the window or house.



OPTIONAL EXTRAS

Ventilation valves

Ventilation valves are aesthetic, compact and provide effective ventilation. They help to create a healthy indoor climate and save energy. Ventilation valves are available for all windows in SeiCom range.



Window and door handles

SeiCom offers a wide range of aluminium handles for windows and doors. All window handles are available with optional child lock (KISI).

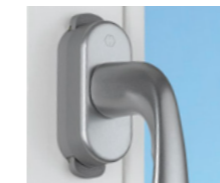

Child lock (KISI)

Conventional window and balcony door handles are easy for children to operate. With the child safety device KISI window and balcony door handles can only be operated with two hands.



Concealed hinges

SeiCom offers concealed hinges, also known as invisible hinges, for all windows. Those type of hinges are completely concealed when the window is closed, giving our windows a contemporary and modern look.



Frame extension for wooden and aluminium clad wooden windows and doors

SeiCom offers additional frame extension to match the wall thickness for all wooden and aluminium clad wooden windows and doors. This feature is especially useful on log houses.





BESPOKE WINDOWS AND DOORS

Here, at SeiCom, we are open for all kinds of bespoke size and style windows, terrace doors and balcony doors. Whether it is the complicated shape, size or function, our team of experienced specialists are always motivated to face new challenges. We work closely together with our suppliers of profiles and hardware to solve even the most demanding projects.

You are welcome to visit us
in our factory to experience
our quality and professional
approach to business.

SeiCom OÜ

Karjamõisa tee 3, Äksi
60543 Tartu county
ESTONIA

sales@seicom.ee
www.seicom.ee